

DATASHEET

Atta

SRFI079 • flexiiANT®



Features

- Antenna for the LTE 410MHz and LTE 450MHz bands
- Maintains high performance within device: DFI (Designed for Integration)
- 1.13mm diameter RF cable with I-PEX MHF connector
- Self-adhesive mounted
- Quick integration minimizes design cycle time
- High efficiency without using the Host PCB for a ground plane
- 150mm cable – (other lengths available, MOQs apply)

1. Description

The Atta antenna operates on the LTE 410MHz and LTE 450MHz bands. Atta is a flexible printed circuit (FPC) antenna with a cable that enables direct connection to the host PCB with an I-PEX coax connector. The host PCB ground is not used, therefore the antenna is easy to integrate.

2. Applications

- LTE 410MHz and LTE 450MHz bands used for data collection such as
- smart metering
- Band 88 LTE410, Uplink:412 – 417MHz, Downlink: 422 – 427 MHz
- Band 72 LTE450, Uplink:451 – 456MHz , Downlink: 461 – 466 MHz
- 433MHz ISM band

3. General data

Frequency	410-470MHz
Polarzation	Linear
Operating temperature	-40°C to +85°C
Environmental condition test	ISO16750-4 5.1.1./5.1.2
Impedance	50 Ω
Weight	<0.5g
Antenna type	FPC Self-adhesive 3M 468MP
Dimensions (Antenna)	101.0 x 20.0 x 0.15 (mm)
Connection	I-PEX MHF1 (20278-112R-13)

4. Part number

SRFI079-150

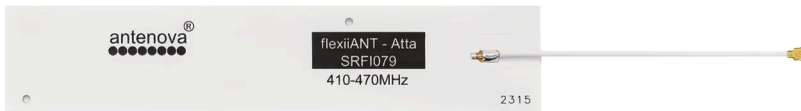

5. RF characteristics

	410-432 MHz	432-434 MHz	434-470 MHz
Peak gain	2.8dBi	1.7dBi	1.1dBi
Average gain (Linear)	-1.7dBi	-2.3dBi	-3.2dBi
Average efficiency	>60%	>55%	>45%
Maximum return loss	-9dB	-9dB	-6dB
Maximum VSWR	2.2:1	2.2:1	3.0:1

All data measured on SRFI079-150 in a loaded condition adhered to a plastic carrier in free space.

6. RF performance

6.1. Return loss

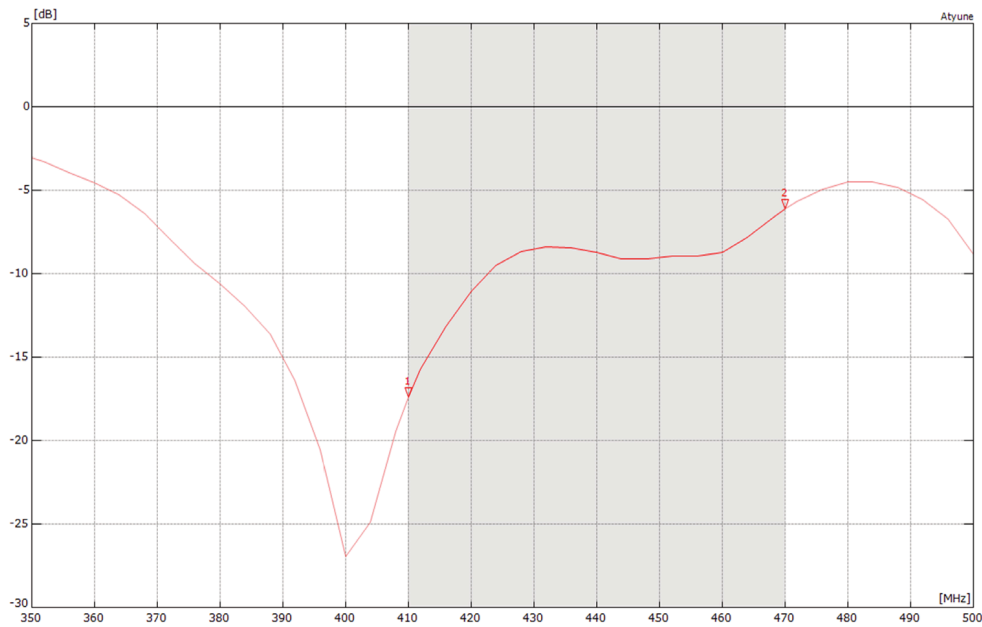

6.2. VSWR

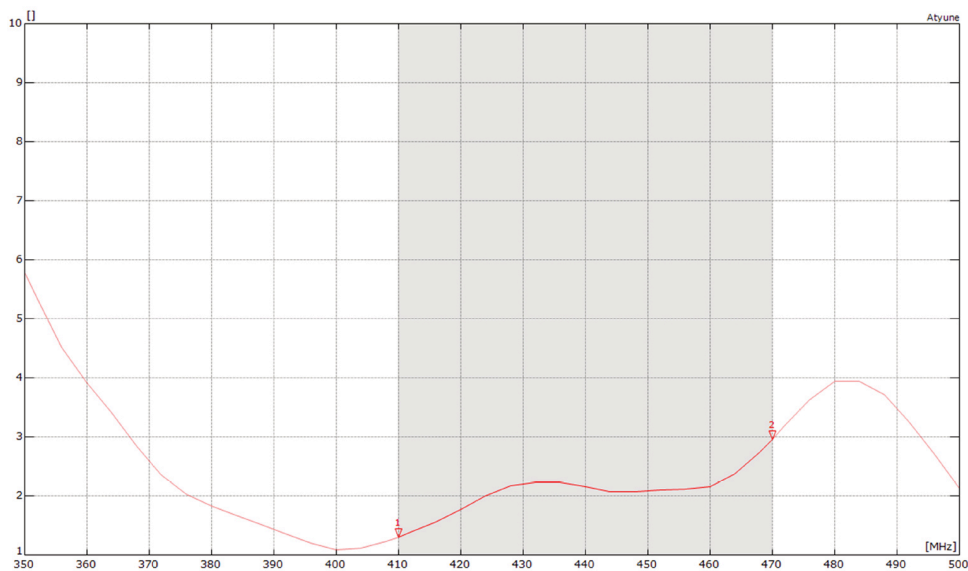

All data measured on SRFI079-150 in a loaded condition adhered to a plastic carrier in free space.

6.3. Efficiency

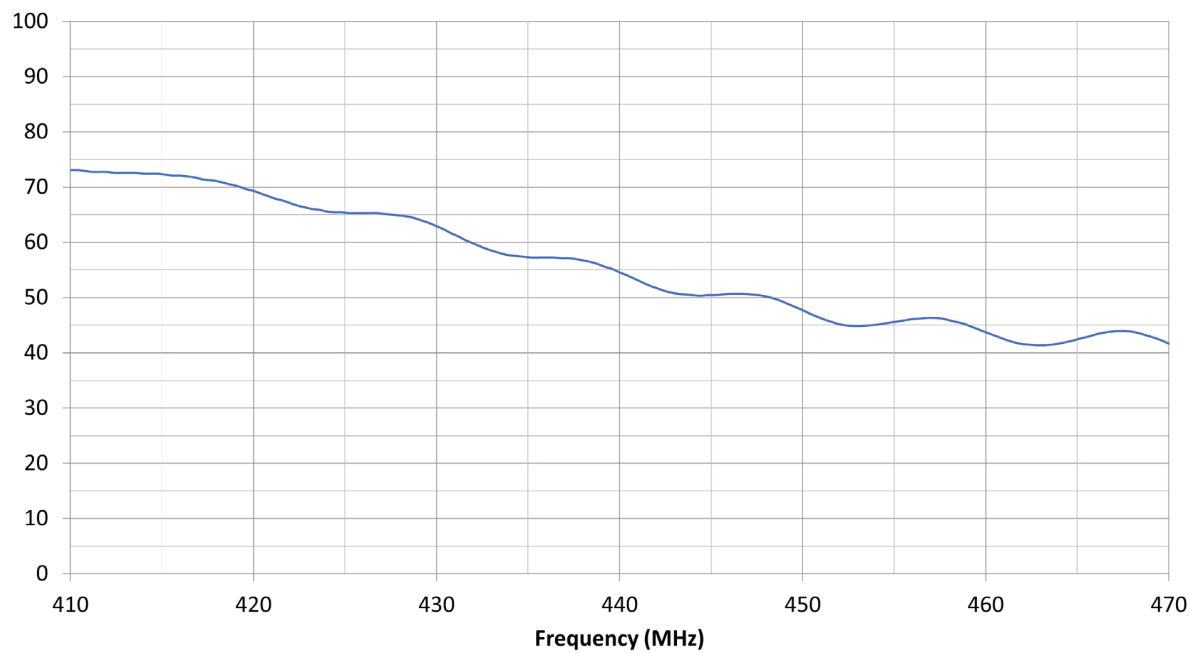

All data measured on SRFI079-150 in a loaded condition adhered to a plastic carrier in free space.

6.4. Antenna pattern

6.4.1. 410 MHz – 470 MHz

3D pattern at 433 MHz

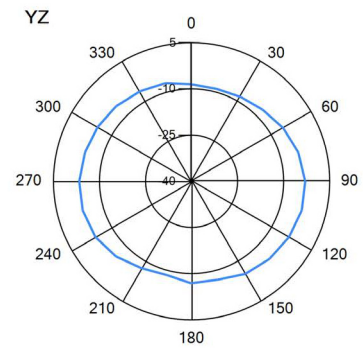
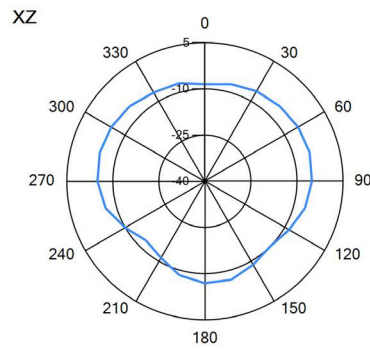
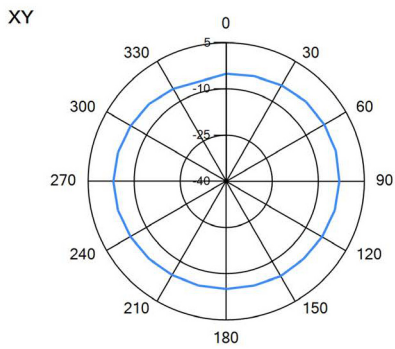
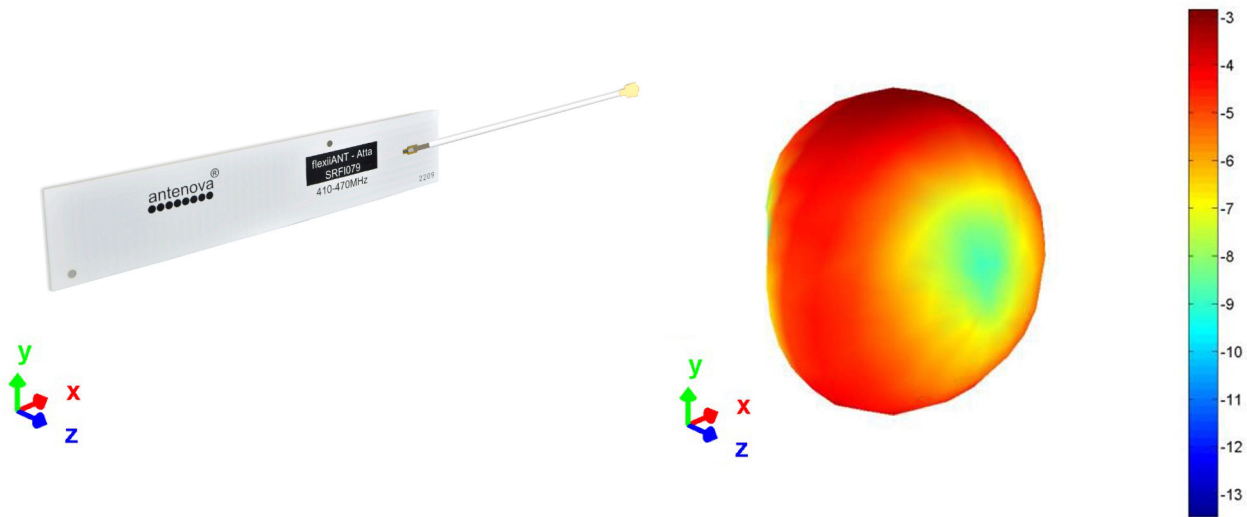

— 433MHz

7. Antenna dimensions

7.1. Dimensions FPC section

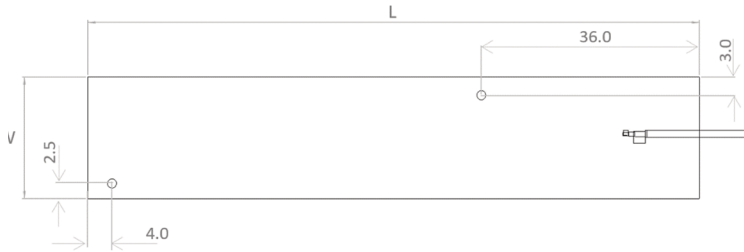

L	W	T
Length	Width	Thickness
101.0 ±0.2	20.0 ±0.2	0.15 (nominal)

All dimensions in (mm)

7.2. Dimensions assembled

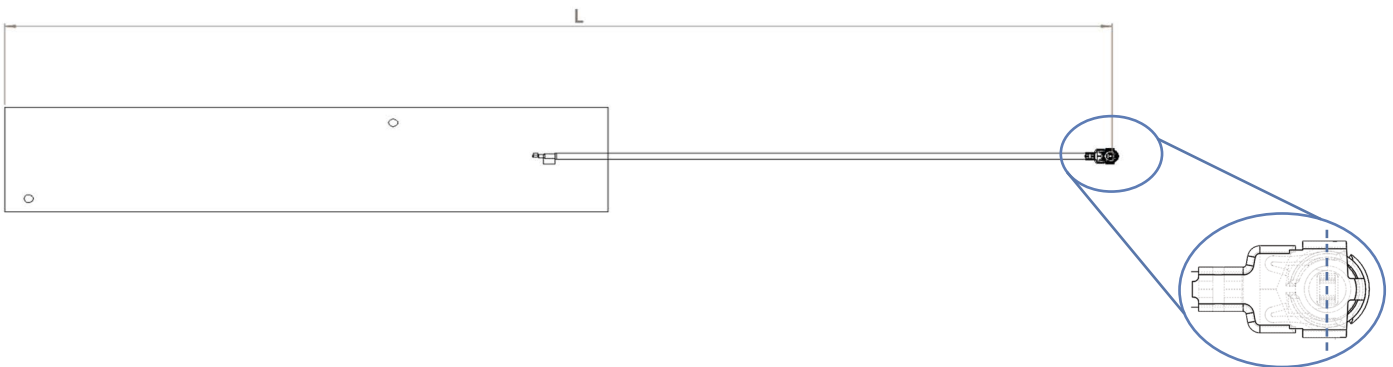

SRFI079-150
Length
239.0 ±2.0

All dimensions in (mm)

Standard cable length for this antenna is 150mm, other lengths are available with a Minimum Order Quantity (MOQ) of 1K.

7.3. I-PEX connector MHF1 (20278-112R-13)

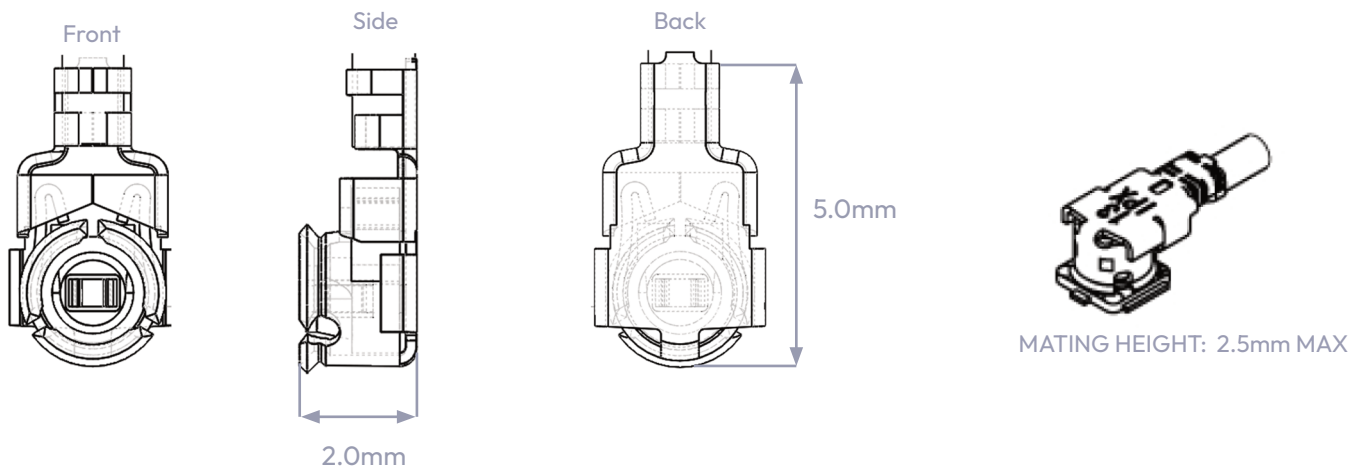

I-PEX	
Material	Copper alloy
Plating	Ag

All dimensions in (mm)

7.4. Assembly

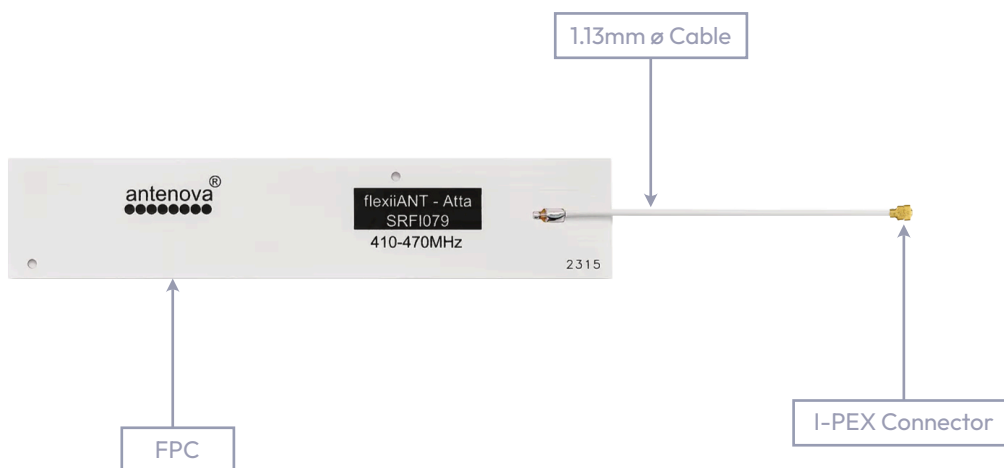

8. Electrical interface

8.1. Host interface

The host PCB requires the mating connector which is the I-PEX MHF (UFL) receptacle. The location should be close to the chip/modules pin for the RF. Any feed from this receptacle should be maintained at 50Ω impedance

8.2. Transmission line

- Must have a characteristic impedance of 50Ω.
- Length should be kept to a minimum.
- Is recommended to be a co-planar waveguide: log on to [Antenova.com](https://www.antenova.com) and try our [Transmission line calculator](#) to easily calculate the dimensions most suited to your requirements.
- Should have DC blocking capacitor (e.g. 220pF) placed in line to protect the RF front end.

9. Mechanical fixing

The antenna uses 3M 468MP adhesive on the reverse side of the FPC. The antenna has an easy access split line to peel off to reveal the adhesive side. It is designed for a one time fix to a clean smooth surface. The antenna is keyed with two 1mm locating holes for easy positioning.

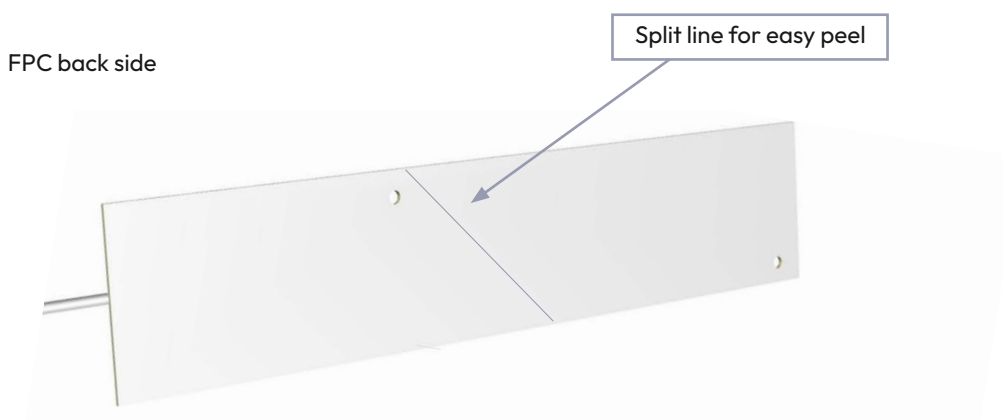

10. Antenna integration guide

We recommend the following during the design phase to maximise antenna performance and minimize noise:

- Minimum 4 layer PCB
- Route signals and power internally where possible
- Flood all layers with ground
- Knit ground on all layers together with plenty of vias

Follow placement guidance carefully. Antenova provide technical support to help you with your design, and also provide design assistance on PTCRB certification. Register for an account on <https://ask.antenova.com/> to access technical support.

10.1. Antenna placement

For FPC antennas the host PCB size is not critical to performance, however consideration must be given to placement. Using six spatial directions, as shown below, the antenna should ideally maintain a minimum of three directions free from obstruction in order to radiate effectively. Where there are obstructions (e.g. PCB, metal parts, battery etc.) a minimum clearance should still be maintained. These minimum clearances are described later in this section.

Six spatial directions relative to FPC

Example with 5 spatial directions clear

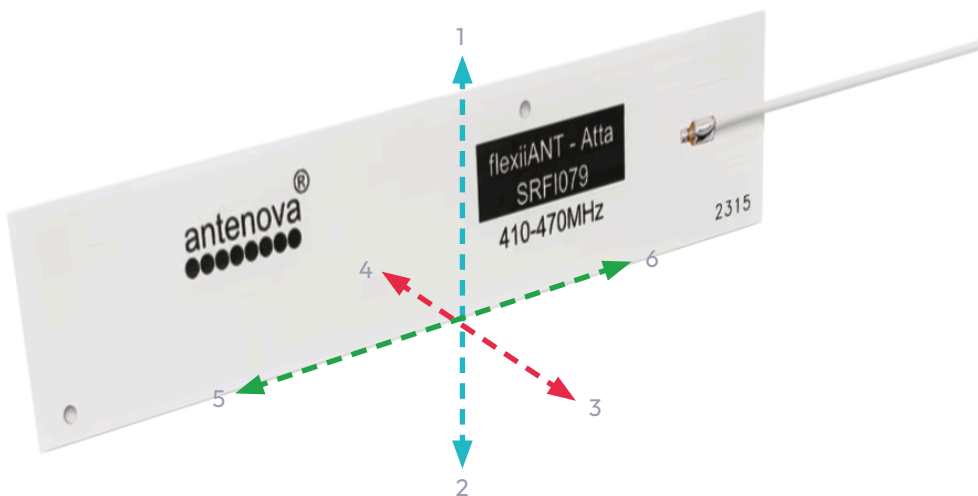

10.2. Orientation of FPC

The orientation of the FPC with respect to the host PCB should be defined depending on the unit. The proximity of the GND will have an influence on the antenna so the PCB location relative to the antenna should be considered.

The FPC will normally be placed in one of the three following options for orientation. In each option a distance (d) is the critical dimension to consider. The diagram below shows the minimum value of (d) for each. Other obstructions may increase this dimension.

Vertical mounted

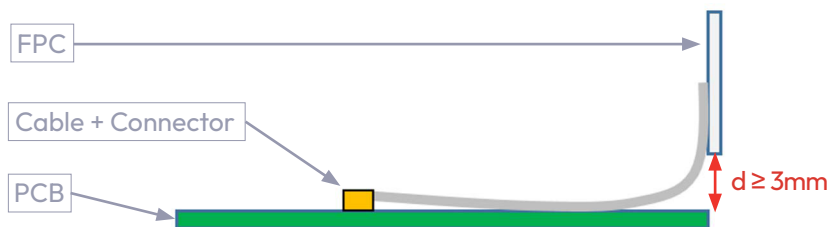

Co-planar to PCB

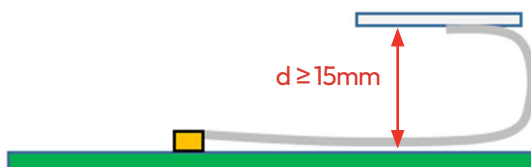

Planar to PCB (Same plane)



11. Hazardous material regulation conformance

The antenna has been tested to conform to RoHS and REACH requirements. A certificate of conformance is available from Antenova's website.

12. Packaging

The antennas are stored within a plastic bag of 100 pcs.

Single antenna per bag



100 units per bag (Labelled)



12.1. Optimal storage conditions

Temperature	-10°C to 40°C
Humidity	Less than 75% RH
Shelf life	18 Months
Storage place	Away from corrosive gas and direct sunlight
Packaging	Antennas should be stored in unopened sealed manufacturer's plastic packaging.

Note: The shelf life of the antenna is 18 months, provided the bag of 100 pieces remains factory- sealed.

12.2. Label information

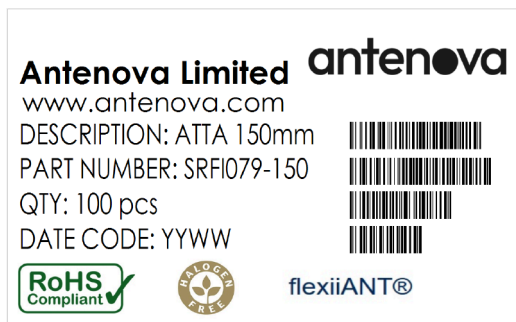

Quality statements

Antenova's products conform to REACH and RoHS legislation. For our statements regarding these and other quality standards, please see [antenova.com](https://www.antenova.com).

Antenova reserves all rights to the contents of this document. Antenova gives no warranties based solely on the accuracy or completeness of the contents of this document and reserves the right to make changes to the specifications of the products described herein at any time and without notice.



Certificate No. 11070
ISO 9001



Datasheet version

2.01 released 8th May 2026

Antenna design, integration and test resources

Product designers – the details contained in this datasheet will help you to complete your embedded antenna design. Please follow our technical advice carefully to obtain optimum antenna performance.

We aim to support our customers to create high performance wireless products. You will find a wealth of design resources, calculators and case studies to aid your design on our website.

Antenuova's design laboratories are equipped with the latest antenna design tools and test chambers. We provide antenna design, test and technical integration services to help you complete your design and obtain the required certifications.

If you cannot find the antenna you require in our product range, please contact us to discuss creating a custom antenna to meet your exact requirements.

Share knowledge with RF Experts around the world

ask.antenuova is a global forum for designers and engineers working with wireless technology

[Visit Ask.Antenuova](#)

Visit antenuova.com

Order antenna samples and evaluation boards, and read our antenna resources

[Visit antenuova.com](http://antenuova.com)

Request a volume quotation for antennas:

sales@antenuova.com

+ 44 (0) 23 9400 1023

Global headquarters

**Antenuova Ltd, 7 The Briars,
Waterberry Drive, Waterlooville,
Hampshire, PO7 7YH**